

# Dell™ 1707FP 평면 컬러 모니터 사용자 안내서

[앞면](#)  
[뒷면](#)  
[옆면](#)  
[밑면](#)

[모니터 사양](#)  
[모니터 관리하기](#)

[스탠드 부착하기](#)  
[케이블 정리하기](#)  
[눅힘각, 좌우 회전, 수직 확장 사용하기](#)  
[스탠드 분리하기](#)

[모니터 연결](#)  
[앞면 패널 사용](#)  
[OSD 사용](#)  
[최적 해상도 설정](#)  
[Dell 사운드바\(선택 품목\) 사용하기](#)

[모니터의 회전각 변경하기](#)  
[운영 체제 회전하기](#)

[모니터 문제 해결](#)  
[일반 문제](#)  
[제품 특정 문제](#)  
[USB 문제](#)  
[사운드바 문제 해결](#)

[FCC 식별 정보](#)  
[안전 정보](#)  
[Dell 연락처](#)  
[모니터 설치 안내서](#)

## 참고, 주의 및 경고



:



:



:

2006 Dell Inc. All rights reserved.

Dell Inc.

OpenManage : Dell, DELL, Inspiron, Dell Precision, Dimension, OptiPlex, Latitude, PowerEdge, PowerVault, PowerApp, Dell  
Dell Inc. Microsoft, Windows, Windows NT, Microsoft Corporation, Adobe  
Adobe Systems Incorporated, ENERGY STAR, Dell Inc., ENERGY STAR

. Dell Inc.

1707FP

2006 2 A01

# 모니터 정보

Dell™ 1707FP

- [앞면](#)
- [뒷면](#)
- [밑면](#)
- [옆면](#)
- [모니터 사양](#)
- [모니터 관리하기](#)

## 앞면

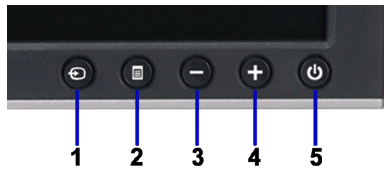

1.	
2.	OSD /
3.	
4.	
5.	( )

## 뒷면

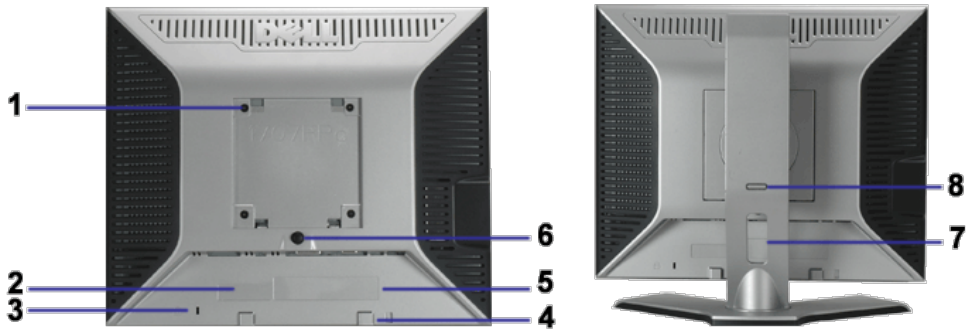

1	VESA (100mm [ ])	
2		Dell
3		
4	Dell	Dell
5		

6		
7		
8	/	

밑면

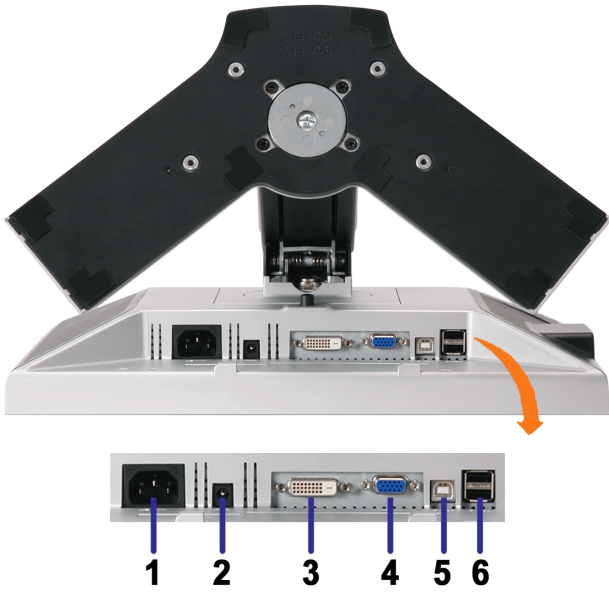

1		
2	Dell	( )
3	DVI	DVI
4	VGA	VGA
5	USB	USB                      USB
6	USB	USB

 :                      USB                      USB

옆면

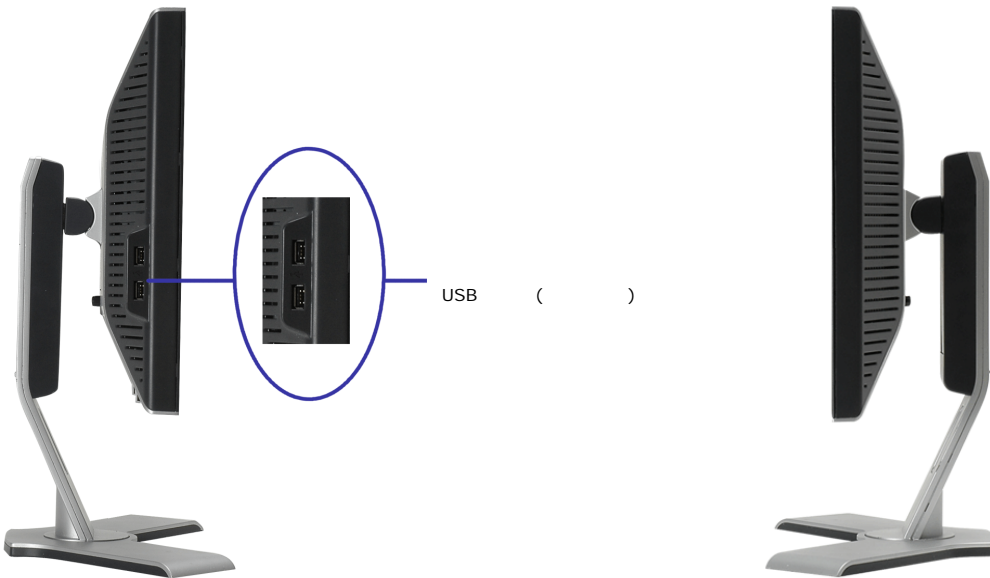

모니터 사양

전원 관리 모드

<b>VESA</b>					
(Dell	USB	)			75W( )
					32 W ( )
-					2W
	-	-	-		1W



: OSD



or



[OSD](#)

ENERGY STAR

TCO '99 / TCO '03



\* (0)

## 핀 지정

### 15핀 D-서브 커넥터

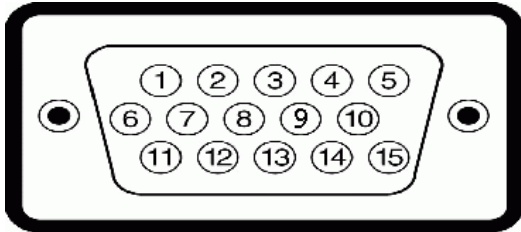

15	
1	-
2	-
3	-
4	GND
5	
6	GND-R
7	GND-G
8	GND-B
9	DDC +5V
10	GND
11	GND
12	DDC
13	
14	
15	DDC

### 24핀 디지털 전용 DVI 커넥터

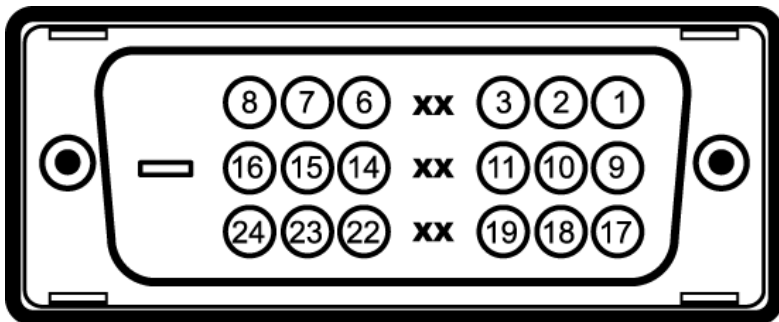



1	T.M.D.S.	2-	9	T.M.D.S.	1-	17	T.M.D.S.	0-
2	T.M.D.S.	2+	10	T.M.D.S.	1+	18	T.M.D.S.	0+
3	T.M.D.S.	2	11	T.M.D.S.	1	19	T.M.D.S.	0
4			12			20		
5			13			21		
6	DDC		14	+5V		22	T.M.D.S.	
7	DDC		15	(+5V )		23	T.M.D.S.	+
8			16			24	T.M.D.S.	-

## 범용 직렬 버스(USB) 인터페이스

USB 2.0



	480 Mbps	2.5W( , )
	12 Mbps	2.5W( , )
	1.5 Mbps	2.5W( , )

USB :

- 1 -
- 4 - 2 , 2



: USB 2.0 2.0

: USB ( )

USB

## 플러그 앤 플레이 기능

(DDC)

(EDID)

## 일반

1707FP

## 평면 패널

- TFT LCD

17 (17 )

337 mm (13.3 )

270 mm (10.6 )

0.264 mm

130° ( ) , 140° ( )

300 CD/m<sup>2</sup>( )

600 1 ( )

3H

CCFL (4)

8 ms ( )

## 해상도

30 kHz ~ 81 kHz( )

56 Hz ~ 76 Hz( )

1280 x 1024(60 Hz )

1280 x 1024(75 Hz )

## 사전 설정 디스플레이 모드

	(kHz)	(Hz)	(MHz)	( / )
VESA, 720 x 400	31.5	70.0	28.3	-/+
VESA, 640 x 480	31.5	60.0	25.2	-/-
VESA, 640 x 480	37.5	75.0	31.5	-/-
VESA, 800 x 600	37.9	60.3	49.5	+/+
VESA, 800 x 600	46.9	75.0	49.5	+/+
VESA, 1024 x 768	48.4	60.0	65.0	-/-
VESA, 1024 x 768	60.0	75.0	78.8	+/+
VESA, 1152 x 864	67.5	75.0	108	+/+
VESA, 1280 x 1024	64.0	60.0	135.0	+/+
VESA, 1280 x 1024	80.0	75.0	135.0	+/+

## 전기

AC	100 ~ 240 VAC / 50	60 Hz $\pm$ 3 Hz / 2.0A ( )
	120V: 42A ( )	
	240V: 80A ( )	

RGB, 0.7 V,  $\pm$  5%, 75  $\Omega$   
 DVI-D TMDS, 600 mV, 50 MHz  
 TTL, (SOG)

## 물리적 특성

15 D-Sub, DVI-D, D-Sub, 15	
( ):	
( )	12.90 (327.62 mm)
( )	18.02 (457.62 mm)
	14.64 (371.81 mm)
	7.16 (181.90 mm)
:( )	
	12.18 (309.25 mm)
	14.64 (371.81 mm)
	2.57 (65.36 mm)
:	
( )	12.90 (327.66 mm)
( )	14.65 (372.20 mm)
	13.27 (337.00 mm)
	7.16 (181.90 mm)
( )	16.98 (7.70 kg)
( )	13.23 (6.00 kg)
	9.13 (4.14 kg)

( )  
( VESA - )

3.31 (1.5 kg)

---

## 환경

:  
5° ~ 35°C(41° ~ 95°F)  
: -20° ~ 60°C (-4° ~ 140°F)  
: -20° ~ 60°C(-4° ~ 140°F)  
:  
10% ~ 80%( )  
: 5% ~ 90% ( )  
: 5% ~ 90%( )  
:  
3,657.6 m(12,000 )  
12,192 m(40,000 )  
256.08 BTU/ ( )  
119.5 BTU/ ( )

---

## 모니터 관리하기



:

[안전 지침](#)



:

- - 
  - 
  - 
  -
- 

[목차 페이지로 돌아가기](#)

---

## Dell™ 1707FP

- \_\_\_\_\_
  - \_\_\_\_\_
  - \_\_\_\_\_
  - \_\_\_\_\_
- 



:

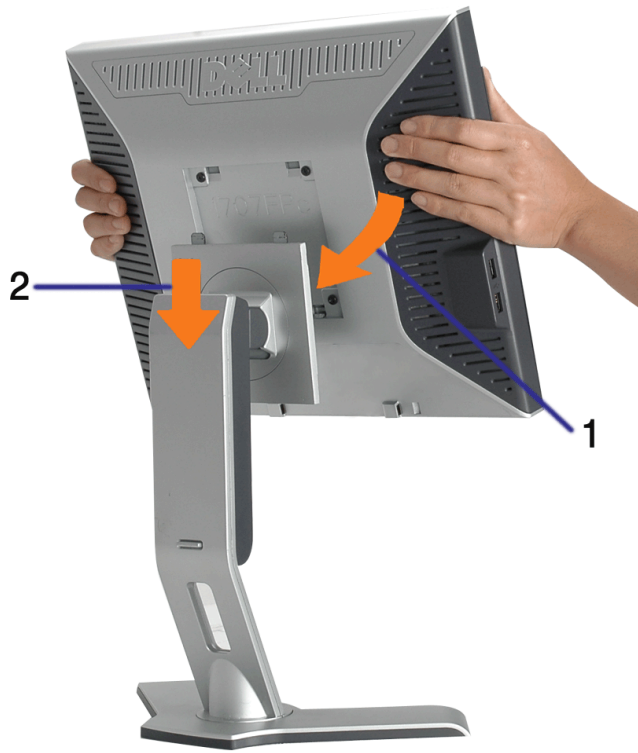

- 1.
  - 2.
-

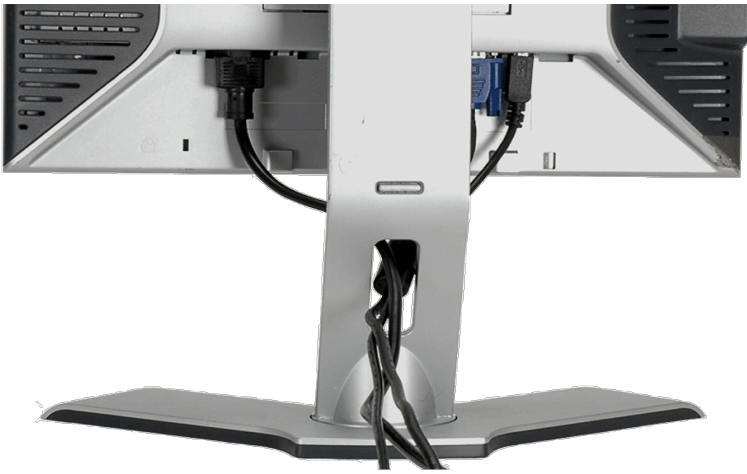

( \_\_\_\_\_ )

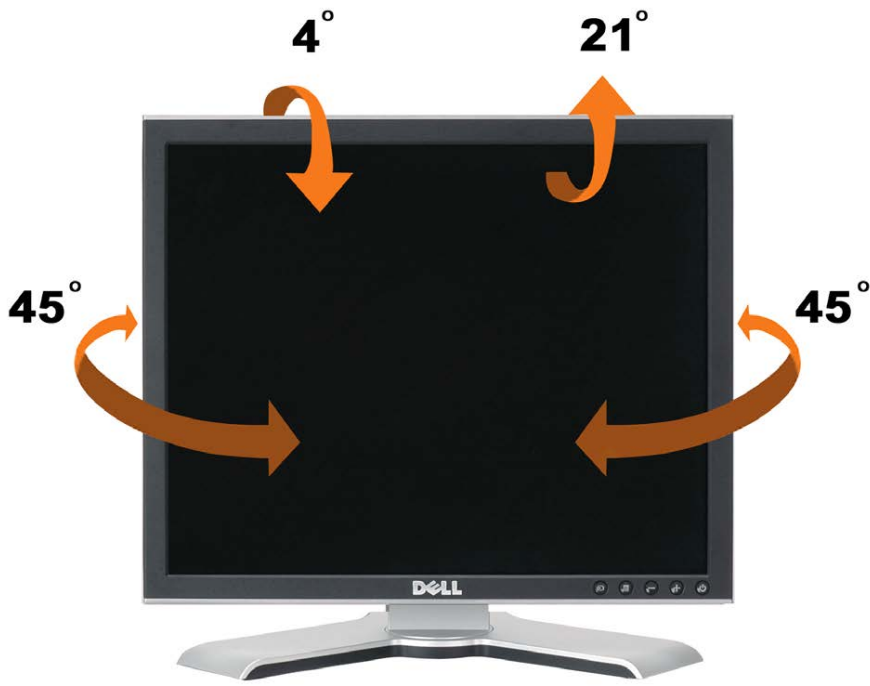

/ 5.12 (130mm)



:

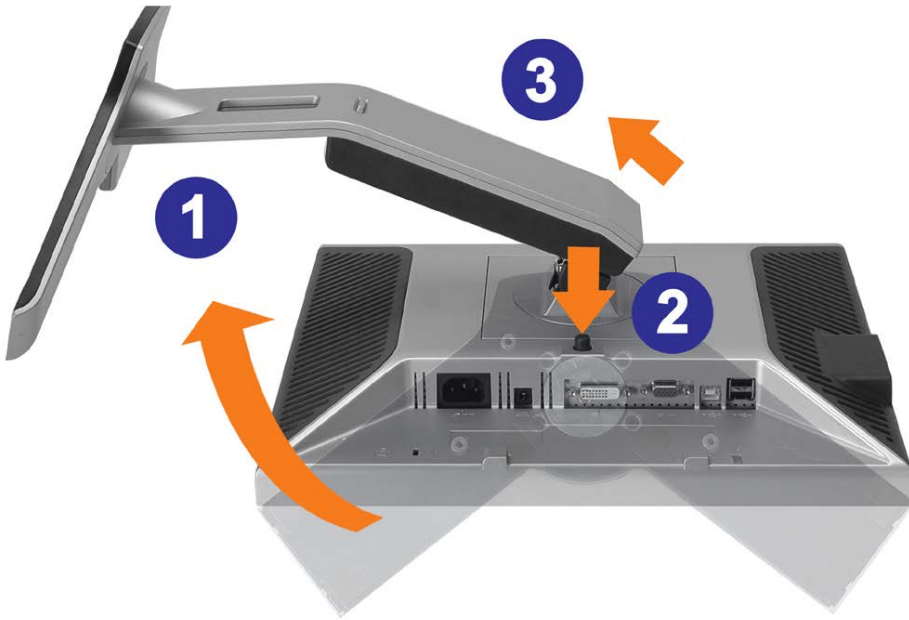

:

- 1.
- 2.



Dell™ 1707FP

- \_\_\_\_\_
- \_\_\_\_\_
- OSD \_\_\_\_\_
- \_\_\_\_\_
- Dell ( \_\_\_\_\_ ) \_\_\_\_\_

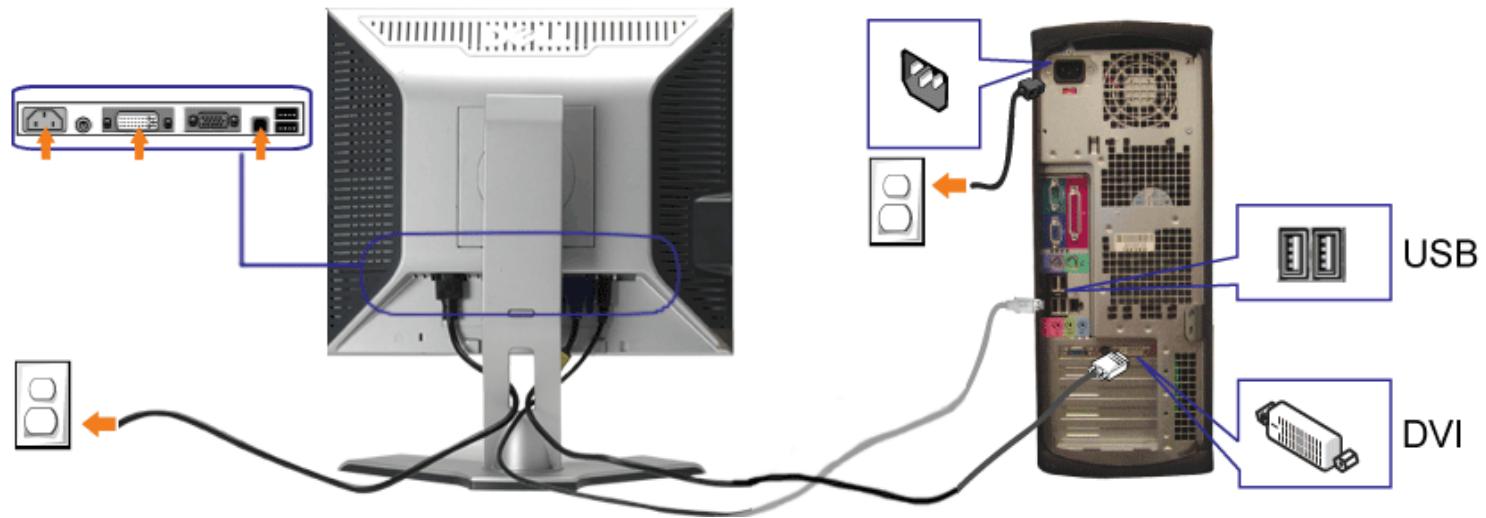

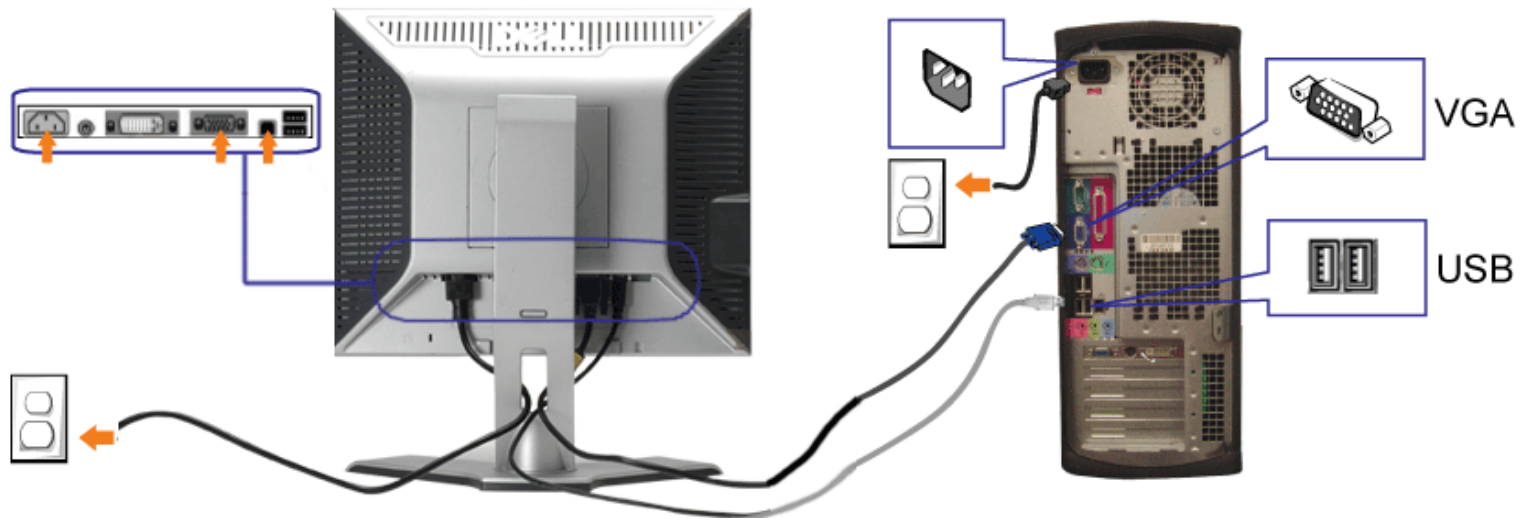

- 1.
2.     DVI         VGA
3.                 USB                             USB                             USB
4. USB
- 5.
6. \_\_\_\_\_

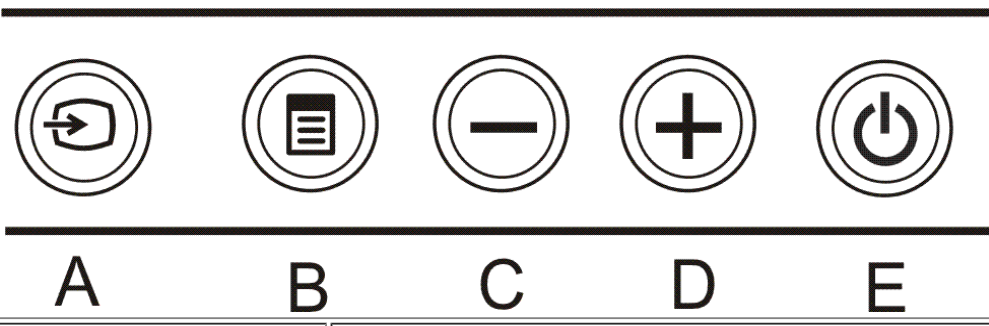





'Dell -

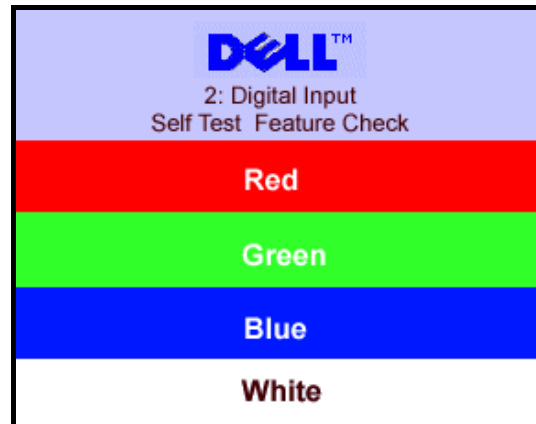
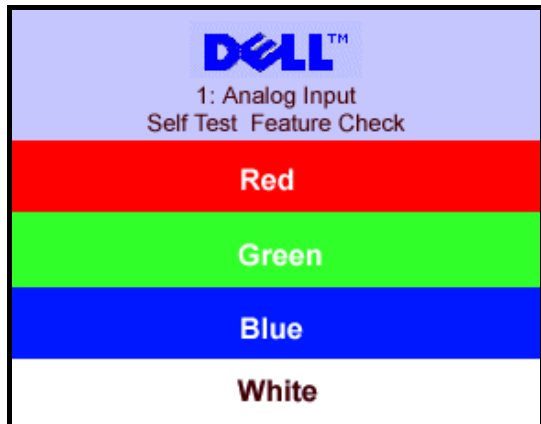

OSD /

OSD

OSD



(-) / (+)

OSD

( / )



## OSD



:

OSD

OSD

1.

OSD

(VGA)

(DVI)

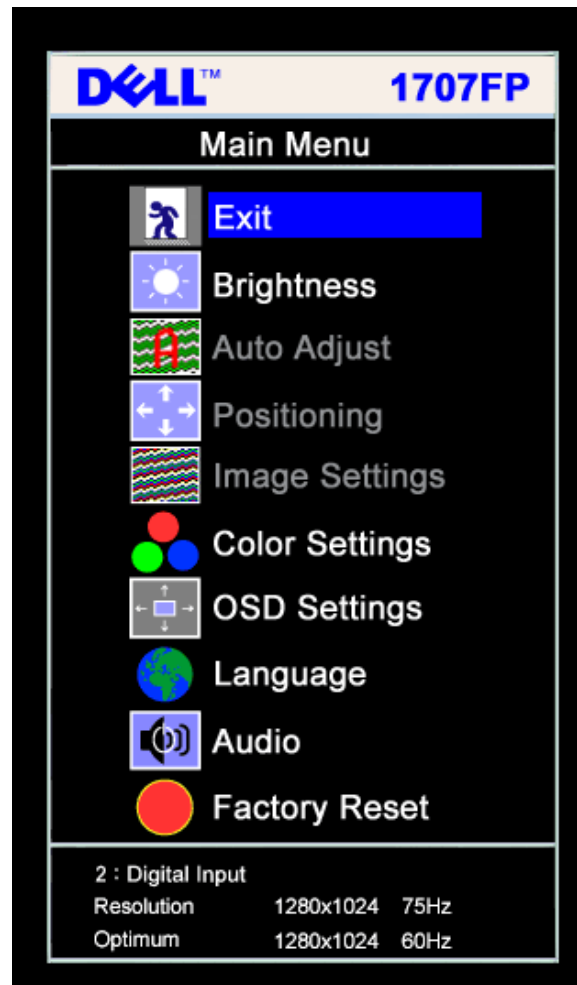
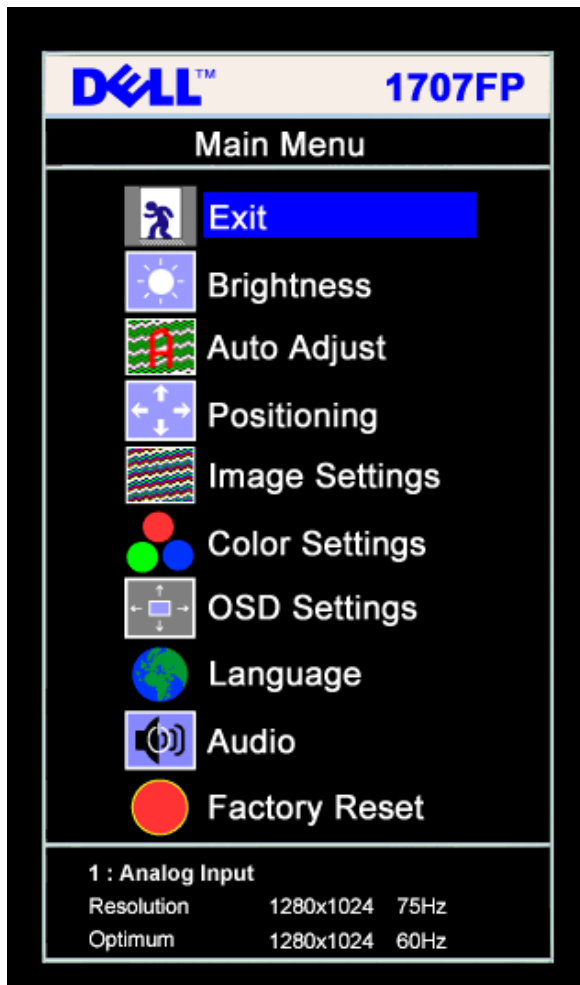

:

(VGA)

2. - +
- 3.
4. - +
5. - +
- 6.

OSD

	/	

+ - ( 0 ~ 100).

+ - ( 0 ~ 100).

**Brightness/Contrast**

<b>Exit</b>		
<b>Brightness</b>		
<b>Contrast</b>		

: DVI



0(-) 100(+)

**Positioning**

<b>Exit</b>		
<b>Horizontal</b>		
<b>Vertical</b>		

: DVI





OSD



:

- +

. ( : 0 ~ : 100)

( )

( )

( )



:

( )

**Image Settings**

<b>Exit</b>		
<b>Pixel Clock</b>		<input type="range" value="50"/>
<b>Phase</b>		<input type="range" value="50"/>



: DVI



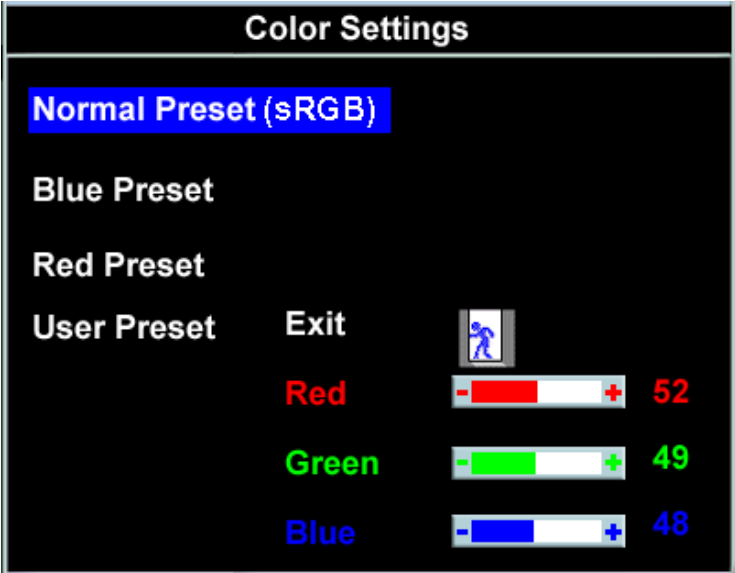











• ( ) : 0 100 "sRGB" (R, G, B)



OSD : OSD OSD  
 OSD :  
 • OSD - + OSD /  
 • OSD - + OSD /  
 OSD :  
 OSD + 5 60 5 OSD  
 OSD : (+)  
 [Eraser icon] : OSD (-) OSD OSD  
 OSD

### On Screen Display (OSD)

Exit		
Horizontal Position		 50
Vertical Position		 50
OSD Hold Time		 20 Sec
OSD Rotation		- No    Yes +
OSD Lock		- No    Yes +

 :      15      OSD



( , , , )      OSD

### Language

	Exit
	English
	Español
	Français
	Deutsch
	日本語

 :      OSD



(  
)  
-      ( )

### Audio On During Power Saving



No -



Yes +



: Dell



OSD

### Reset to Factory Settings



Exit



Position Settings Only



Color Settings Only



All Settings

DDC/CI - Enable

Disable +

- OSD

**DDC/CI** - DDC/CI 제어 기능을 활성화합니다.

기본값은 "사용"입니다. "사용 안 함"을 선택하여 이 기능을 사용하지 않도록 설정할 수 있습니다.

최상의 사용자 경험과 모니터의 최적 성능을 위해서는 이 기능을 사용하도록 설정해 놓으십시오.

DDC/CI ( / ) PC ( , )



: "Disable ( )"

"Yes ( )"

. DDC/CI 20

" Reset to Factory Settings

The function of adjusting display settings using PC applications will be disabled.

Do you want to disable DDC/CI?  Yes +

## OSD

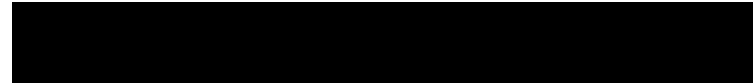
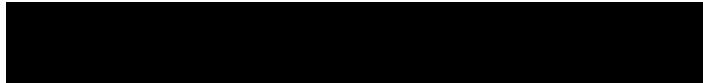

1280 x 1024 @ 60 Hz



'Dell -

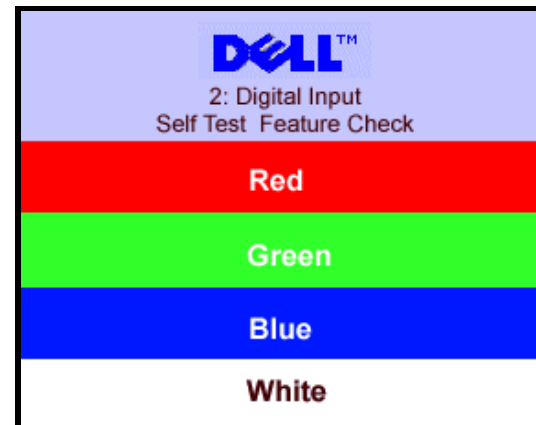
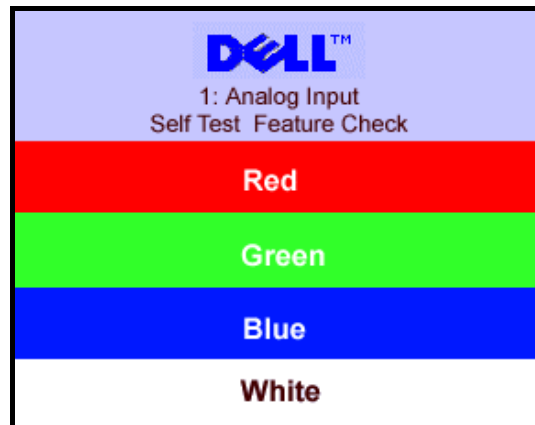

- 1.
- 2.
- 3.
- 4.

1280 x 1024

1280 x 1024



Dell

◦ [support.dell.com](http://support.dell.com)

Dell ( ) :

◦  
◦

## Dell ( )

Dell

Dell

2

/

,

LED 2

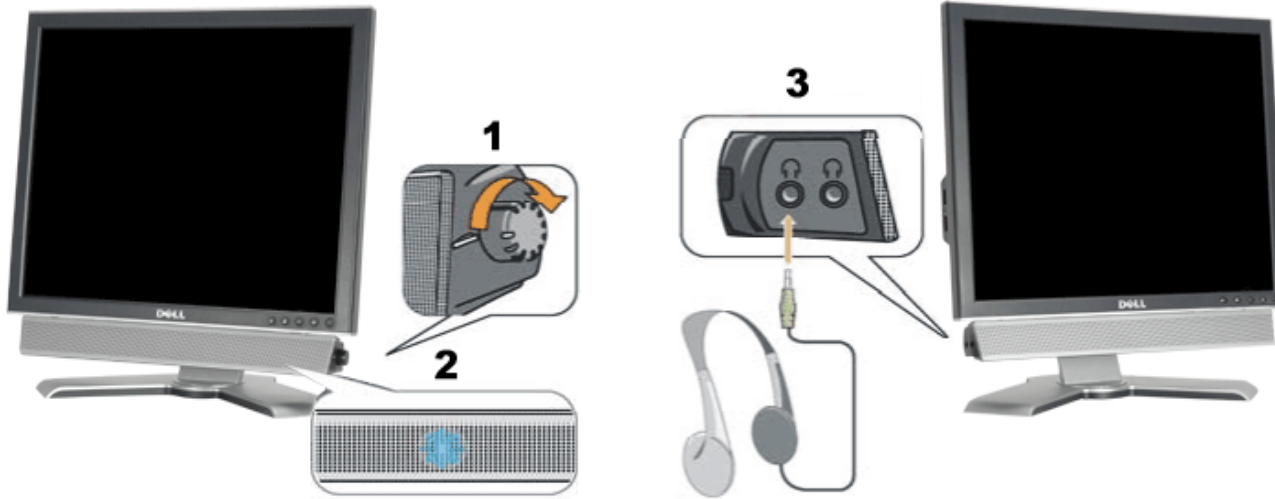

1. /
- 2.
- 3.

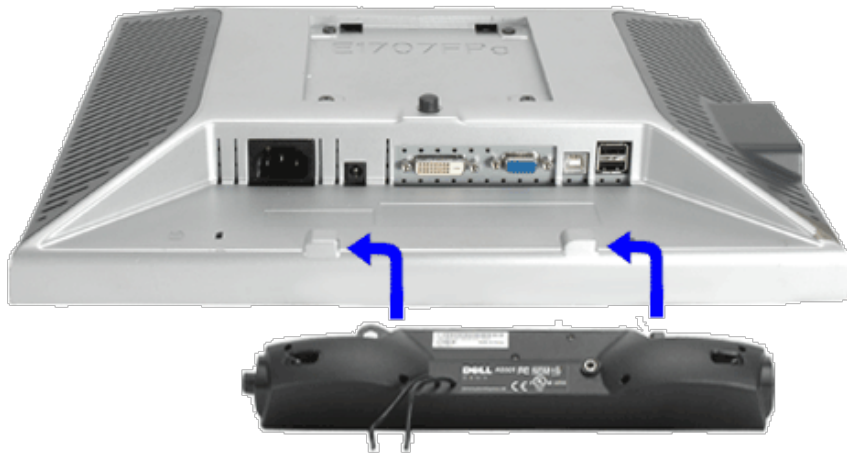

- 1.
- 2.
- 3.
- 4.



:

-12V DC

Dell



: DELL

---

Dell™ 1707FP

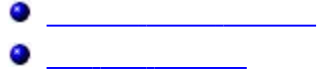

( )

( )



 : Dell

- 1.
- 2.
3. ATI  
nVidia  
Intel

nVidia

NVRotate

 : [support.dell.com](http://support.dell.com)

# 문제 해결

## Dell™ 1707FP

- [모니터 문제 해결](#)
- [일반 문제](#)
- [제품 특정 문제](#)
- [USB 문제](#)
- [사운드바 문제 해결](#)



[안전 수칙](#)

## 모니터 문제 해결

### 자체 검사 기능 점검 (STFC)

- 1.
2. ( ) ( )
- 3.

LED

'Dell -

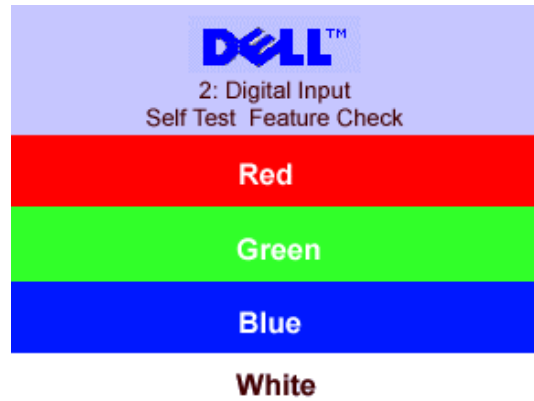
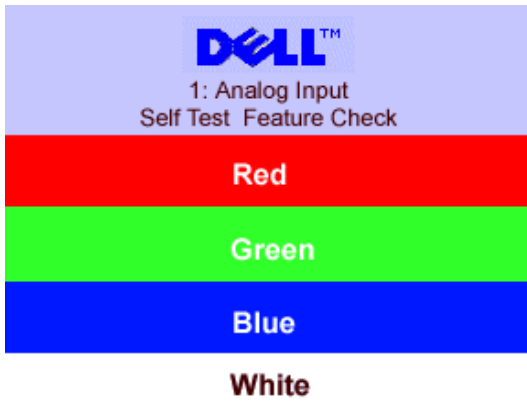

- 5.
- 6.

### OSD 경고 메시지

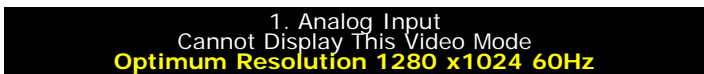

or



[모니터 명세](#)

1280 x 1024 @ 60 Hz

# 일반 문제

LED /		
LED /		<ul style="list-style-type: none"> <li>•</li> <li>•</li> <li>•</li> <li>•</li> <li>•</li> </ul>
		<ul style="list-style-type: none"> <li>• OSD</li> <li>•</li> <li>•</li> <li>•</li> </ul>
/		<ul style="list-style-type: none"> <li>• OSD</li> <li>•</li> <li>•</li> <li>•</li> <li>•</li> </ul>
	LCD	<ul style="list-style-type: none"> <li>•</li> <li>•</li> </ul> <p style="text-align: right;">LCD</p>
		<ul style="list-style-type: none"> <li>•</li> <li>•</li> <li>•</li> </ul>
		<ul style="list-style-type: none"> <li>• " "</li> <li>•</li> <li>•</li> <li>•</li> </ul>
/		<ul style="list-style-type: none"> <li>•</li> <li>• OSD</li> <li>•</li> <li>•</li> </ul>
		<ul style="list-style-type: none"> <li>•</li> <li>• OSD</li> <li>•</li> <li>• " "</li> <li>•</li> </ul>
LCD		<ul style="list-style-type: none"> <li>•</li> <li>•</li> </ul> <p style="text-align: center;"><a href="#">모니터 관리하기</a></p>
		<ul style="list-style-type: none"> <li>•</li> <li>•</li> </ul>
		<ul style="list-style-type: none"> <li>•</li> <li>•</li> <li>•</li> <li>•</li> </ul>
( )		<ul style="list-style-type: none"> <li>•</li> </ul>

## 제품 특정 문제

		<ul style="list-style-type: none"> <li>• " "</li> </ul>
	OSD	<ul style="list-style-type: none"> <li>•</li> </ul>

## USB 문제

USB	USB	<ul style="list-style-type: none"> <li>•</li> <li>•</li> <li>• USB ( )</li> <li>•</li> </ul>
USB 2.0	USB 2.0	<ul style="list-style-type: none"> <li>• USB 2.0</li> <li>• USB 2.0</li> <li>•</li> <li>• USB ( )</li> </ul>

## 사운드바 문제 해결

( DC 1905FP)		<ul style="list-style-type: none"> <li>• / ( LED)</li> <li>•</li> <li>•</li> <li>•</li> </ul> <p><a href="#">모니터 문제 해결</a></p>
		<ul style="list-style-type: none"> <li>• Windows ( CD MP3)</li> <li>• /</li> <li>• ( CD )</li> </ul>
		<ul style="list-style-type: none"> <li>• Windows</li> <li>• /</li> <li>•</li> <li>• ( CD )</li> </ul>
		<ul style="list-style-type: none"> <li>•</li> <li>•</li> <li>• /</li> <li>•</li> </ul>
		<ul style="list-style-type: none"> <li>•</li> </ul>

		<ul style="list-style-type: none"> <li>• Windows ( / )</li> <li>• -</li> <li>•</li> <li>• ( CD )</li> </ul>
		<ul style="list-style-type: none"> <li>• /</li> <li>• Windows</li> <li>•</li> <li>• ( CD )</li> </ul>

[목차 페이지로 돌아가기](#)

Dell™ 1707FP

FCC

:

Dell

## FCC

FCC ( )

### FCC Class B

FCC 15 Class B

FCC 15

1

2

➔ : FCC Dell Inc.

( )

- 
- 
- 
- 

Dell Inc. /

FCC

- :1707FP
- :1707FPc
- :

Dell Inc.

Worldwide Regulatory Compliance & Environmental Affairs

One Dell Way

Round Rock, TX 78682 USA 512-338-4400

:



:



(AC)

(220V/60Hz),

115V/60Hz

230V/50Hz  
AC



- 
- 
- LCD
- 
- LCD
- 

LCD

LCD

, LCD

LCD

( , )

Hg

(EIA, <http://www.eiae.org/>)

## Dell

Dell

- [www.dell.com](http://www.dell.com)
- [support.dell.com](http://support.dell.com)( )



:



XPS

:

Dell XPS™

Dell

Dell

( )		
		: 800-335-0031
		1-800-805-5924
	: <a href="http://www.dell.com.ar">www.dell.com.ar</a>	
(	: <a href="mailto:us_latin_services@dell.com">us_latin_services@dell.com</a>	
	:	

) : 00 : 54 : 11	la-techsupport@dell.com	
	EMC la_enterprise@dell.com	
		: 0-800-444-0730
		: 0-800-444-0733
		: 0-800-444-0724
		0-810-444-3355
		: 800-1578
) ( : 0011 : 61 : 2	: support.ap.dell.com	
	: support.ap.dell.com/contactus	
		13DELL-133355
( ) : 900 : 43 : 1	: support.euro.dell.com	
	: tech_support_central_europe@dell.com	
	/	0820 240 530 00
	/	0820 240 530 49
	/	0820 240 530 14
	/	0820 240 530 16
	XPS	0820 240 530 81
	Dell /	0820 240 530 14
	/	0660 8779
		0820 240 530 00
		: 1-866-278-6818
		1-800-534-3066
( ) : 00 : 32 : 2	: support.euro.dell.com	
	XPS	02 481 92 96
	Dell	02 481 92 88
		02 481 92 95
		02 713 15 65
		02 481 91 00
		02 481 92 99
		02 481 91 00
		1-800-342-0671
		: 800-10-0238
: 00 : 55 : 51	: www.dell.com/br	
	,	0800 90 3355
		51 481 5470
		51 481 5480
		0800 90 3390
		: 1-866-278-6820
: 673	( , )	604 633 4966
	( , )	604 633 4888
	( , )	604 633 4955
( ,	: www.dell.ca/ostatus	
	AutoTech( )	: 1-800-247-9362
	( / )	: 1-800-847-4096
	( / , )	: 1-800-326-9463
	( ) , , , ,	: 1-800-847-4096

) : 011	( / )	: 1-800-906-3355
	( / , )	: 1-800-387-5757
	( ; ' ' )	1-877-335-5767
	( / )	: 1-800-387-5752
	( / , )	: 1-800-387-5755
	&	1 866 440 3355
		1-800-805-7541
( ) : 56 : 2		: 1230-020-4823
( ) : 86 : 592	: support.dell.com.cn	
	: cn_support@dell.com	
	: customer_cn@dell.com	
		592 818 1350
	(Dell Dimension Inspiron)	: 800 858 2968
	(OptiPlex, Latitude Dell Precision)	: 800 858 0950
	( )	: 800 858 0960
	( , PDA, , , )	: 800 858 2920
	( )	: 800 858 2311
		: 800 858 2060
		592 818 1308
		: 800 858 2222
		: 800 858 2557
	GCP	: 800 858 2055
		: 800 858 2628
		: 800 858 2999
		: 800 858 2955
		: 800 858 2020
		: 800 858 2669
		: 800 858 2572
	: 800 858 2355	
	: 800 858 2811	
	: 800 858 2621	
		980-9-15-3978
		0800-012-0435
( ) : 00 : 420	: support.euro.dell.com	
	: czech_dell@dell.com	
		22537 2727
		22537 2707
		22537 2714
		22537 2728
	22537 2711	
( ) : 00 : 45	: support.euro.dell.com	
	XPS	7010 0074
	Dell	7023 0182
	( )	7023 0184
	/	3287 5505
	( )	3287 1200
	3287 1201	

	( / )	3287 5000
	( / )	3287 5001
		: 1-866-278-6821
		1-800-148-0530
		: 999-119
		01-899-753-0777
( )	: support.euro.dell.com	
: 990		09 253 313 60
: 358		09 253 313 38
: 9		09 253 313 99
		09 253 313 00
) ( ) ( )	: support.euro.dell.com	
	XPS	0825 387 129
	Dell	0825 387 270
		0825 823 833
		0825 004 700
	( )	04 99 75 40 00
	: 00	0825 004 700
	: 33	0825 004 701
	: (1) (4)	04 99 75 40 01
		0825 004 719
		0825 338 339
		01 55 94 71 00
	01 55 94 71 00	
	01 55 94 71 01	
( )	: support.euro.dell.com	
	: tech_support_central_europe@dell.com	
	XPS	06103 766-7222
	Dell	06103 766-7200
	/	0180-5-224400
		06103 766-9570
		06103 766-9420
		06103 766-9560
		06103 766-9555
	06103 766-7000	
: 00 : 49 : 6103	: support.euro.dell.com	
		00800-44 14 95 18
		00800-44 14 00 83
		2108129810
		2108129811
		2108129800
		2108129812
	: 1-866-540-3355	
	1-800-999-0136	
	: 1-877-270-4609	
	: support.ap.dell.com	
	: HK_support@Dell.com	
	(Dimension Inspiron)	2969 3188
	(OptiPlex, Latitude Dell Precision)	2969 3191
	(PowerApp, PowerEdge, PowerConnect)	

: 001 : 852	PowerVault)	2969 3196
		3416 0910
		3416 0907
		3416 0908
		3416 0912
		2969 3105
	: india_support_desktop@dell.com india_support_notebook@dell.com india_support_Server@dell.com	
		1600338045 1600448046
	( )	1600 33 8044
	( / )	1600 33 8046
( ) : 00 : 353 : 1	: support.euro.dell.com	
	: dell_direct_support@dell.com	
	XPS	1850 200 722
	Dell	1850 543 543
	( )	0870 908 0800
		01 204 4014
		01 204 4014
	( )	0870 906 0010
		1850 200 982
	( )	0870 907 4499
		01 204 4444
	( )	0870 907 4000
	/	01 204 0103
		01 204 4444
( ) : 00 : 39 : 02	: support.euro.dell.com	
		02 577 826 90
		02 696 821 14
		02 696 821 13
		02 696 821 12
		02 577 826 90
		02 577 825 55
		02 575 035 30
	02 577 821	
	( )	1-800-682-3639
( ) : 001 : 81 : 44	: support.jp.dell.com	
	( )	: 0120-198-498
	( )	81-44-556-4162
	(Dimension Inspiron)	: 0120-198-226
	(Dimension Inspiron)	81-44-520-1435
	(Dell Precision, OptiPlex Latitude)	: 0120-198-433
	(Dell Precision, OptiPlex Latitude)	81-44-556-3894
	(PDA, , , )	: 0120-981-690
	(PDA, , , )	81-44-556-3468
	Faxbox	044-556-3490
	24	044-556-3801
		044-556-4240

	( 400 )	044-556-1465
	( 400 )	044-556-3433
	( 3500 )	044-556-3430
	( , )	044-556-1469
		044-556-3469
		044-556-1760
		044-556-4300
( )	: krsupport@dell.com	
: 001		: 080-200-3800
: 82	(Dimension, PDA, )	: 080-200-3801
: 2		: 080-200-3600
		2194-6202
		2194-6000
	( , , )	512 728-4093
	( , , )	512 728-3619
	( )( , , )	512 728-3883
	( , , )	512 728-4397
	SalesFax( , , )	512 728-4600
		512 728-3772
	: support.euro.dell.com	
: 00		342 08 08 075
: 352	/	+32 (0)2 713 15 96
		26 25 77 81
		+32 (0)2 481 91 19
		26 25 77 82
: 853		: 0800 105
	( , )	34 160 910
	( , )	29 693 115
( )	: support.ap.dell.com	
: 00	(Dell Precision, OptiPlex Latitude)	: 1 800 880 193
: 60	(Dimension, Inspiron )	: 1 800 881 306
: 4	(PowerApp, PowerEdge, PowerConnect PowerVault)	: 1800 881 386
		: 1800 881 306( 6)
		: 1 800 888 202
		: 1 800 888 213
: 00		001-877-384-8979
: 52		001-877-269-3383
		50-81-8800
		01-800-888-3355
		001-877-384-8979
		001-877-269-3383
		50-81-8800
		01-800-888-3355
		: 1-866-278-6822
		001-800-882-1519
( )	: support.euro.dell.com	
	XPS	020 674 45 94
	Dell	020 674 45 00
		020 674 47 66
	/	020 674 42 00

: 00 : 31 : 20		020 674 4325
	/	020 674 55 00
		020 674 50 00
	/	020 674 47 75
		020 674 47 50
		020 674 50 00
		020 674 47 50
: 00 : 64	: support.ap.dell.com	
	: support.ap.dell.com/contactus	
		0800 441 567
		001-800-220-1006
( ) : 00 : 47	: support.euro.dell.com	
	XPS	815 35 043
	Dell	671 16882
		671 17575
	/	23162298
		671 16800
		671 16865
		001-800-507-0962
		0800-50-669
( ) : 011 : 48 : 22	: support.euro.dell.com	
	: pl_support_tech@dell.com	
		57 95 700
		57 95 999
		57 95 999
		57 95 806
		57 95 998
	57 95 999	
: 00 : 351	: support.euro.dell.com	
		707200149
		800 300 413
		800 300 410    800 300 411    800 300 412    21 422 07 10
		21 424 01 12
		1-800-805-7545
		: 1-877-441-4731
		1-800-882-1521
		: 1-877-270-4609
( ) : 005 : 65	: support.ap.dell.com	
	(Dimension, Inspiron )	: 1800 394 7430
	(OptiPlex, Latitude Dell Precision)	: 1800 394 7488
	(PowerApp, PowerEdge, PowerConnect PowerVault)	: 1800 394 7478
		: 1,800,394 7430( 6)
		: 1 800 394 7412
	: 1 800 394 7419	
) ( : 00	: support.euro.dell.com	
	: czech_dell@dell.com	
		02 5441 5727
		420 22537 2707

: 421		02 5441 8328
		02 5441 8328
	( )	02 5441 7585
) ( : 09/091 : 27 : 11	: support.euro.dell.com	
	: dell_za_support@dell.com	
		011 709 7713
		011 709 7710
		011 709 7707
		011 709 7700
		011 706 0495
		011 709 7700
	( , )	604 633 4810
( ) : 00 : 34 : 91	: support.euro.dell.com	
		902 100 130
		902 118 540
		902 118 541
		902 118 541
		902 118 539
		902 100 130
		902 115 236
		91 722 92 00
		91 722 95 83
( ) : 00 : 46 : 8	: support.euro.dell.com	
	XPS	0771 340 340
	Dell	08 590 05 199
		08 590 05 642
	/	08 587 70 527
	(EPP)	20 140 14 44
		08 590 05 594
		08 590 05 185
( ) : 00 : 41 : 22	: support.euro.dell.com	
	: Tech_support_central_Europe@dell.com	
	XPS	0848 33 88 57
	Dell ( )	0844 811 411
	( )	0844 822 844
	( )	0848 802 202
	( )	0848 821 721
		022 799 01 90
	022 799 01 01	
: 002 : 886	: support.ap.dell.com	
	: ap_support@dell.com	
	(OptiPlex, Latitude, Inspiron, Dimension )	: 00801 86 1011
	(PowerApp, PowerEdge, PowerConnect PowerVault)	: 00801 60 1256
		: 00801 60 1250 ( 5)
		: 00801 65 1228
		: 00801 651 227
	: support.ap.dell.com	



: 001 : 66	(OptiPlex, Latitude Dell Precision)	: 1800 0060 07
	(PowerApp, PowerEdge, PowerConnect PowerVault)	: 1800 0600 09
		: 1800 006 007 ( 7)
		: 1800 006 009
		: 1800 006 006
		1-800-805-8035
		: 1-866-540-3355
( ) : 00 : 44 : 1344	: support.euro.dell.com	
	support.euro.dell.com/uk/en/ECare/Form/Home.asp	
	: dell_direct_support@dell.com	
	( / /PAD [ 1000 ])	0870 908 0500
	XPS	0870 366 4180
	( )	0870 908 0800
		01344 373 186
		0870 906 0010
		01344 373 185
	( 500-5000 )	0870 906 0010
		01344 373 193
	&	01344 373 199
		01344 373 194
		0870 907 4000
	/	01344 860 456
	0870 907 4006	
	: 000-413-598-2521	
( , ) : 011 : 1	-	: 1-800-433-9014
	AutoTech( )	: 1-800-247-9362
	( Dell TV, )	: 1-877-459-7298
	XPS	: 1-800-232-8544
	Dell ( )	: 1-800-624-9896
		: 1-800-624-9897
	(EPP)	: 1-800-695-8133
	www.dellfinancialservices.com	
	( / )	: 1-877-577-3355
	(Dell [DPA])	: 1-800-283-2210
		: 1-800-456-3355
	(EPP)	: 1-800-695-8133
	, , PDA MP3	: 1-877-459-7298
	( , )	
		: 1-800-456-3355
	(EPP)	: 1-800-695-8133
	Dell	: 1-800-289-3355 : 1-800-879-3355
	Dell (Dell )	: 1-888-798-7561
		: 1-800-671-3355
	: 1-800-357-3355	
	: 1-800-247-4618	
	: 1-800-727-8320	

	Dell	: 1-877-DELLTTY (1-877-335-5889)
		1-877-673-3355
		8001-3605

PDF ( .pdf ) , Microsoft Internet Explorer Netscape Navigator

[\\_\\_\\_\\_\\_ \(.pdf\)](#)

 :PDF Adobe Acrobat Reader www.adobe.com  
 .PDF Acrobat Reader PDF

[\\_\\_\\_\\_\\_](#)



# Setting Up Your Monitor

Paramétrer votre moniteur | Instalación del monitor | Instalar o monitor |  
Inbetriebnahme des Monitors | Configurazione del monitor | Instalacja monitora



**CAUTION:**

**MISE EN GARDE :**

**PRECAUCIÓN:**

**ATENÇÃO:**

**ACHTUNG:**

**ATTENZIONE:**

**OSTRZEŻENIE:**

## Dell™ 1707FP Flat Panel Monitor

Before you set up and operate your Dell monitor, see the safety instructions in your monitor "Product Information Guide." See your User's Guide for a complete list of features.

Avant d'installer et d'utiliser votre écran Dell, veuillez vous référer aux consignes de sécurité données dans le "Guide des Informations du Produit" de votre moniteur. Consultez également votre Guide Utilisateur pour obtenir la liste complète des fonctions.

Antes de configurar y utilizar el monitor Dell, consulte las instrucciones de seguridad contenidas en la "Guía de información del producto" que acompaña al monitor. Consulte también la Guía del usuario para obtener una lista completa de las funciones.

Antes de instalar e utilizar o seu monitor Dell, consulte as normas de segurança no "Guia de informação do produto" do seu monitor. Consulte também o Guia do utilizador para obter a lista completa de funções.

Bevor Sie Ihren Dell-Monitor einrichten und in Betrieb setzen, lesen Sie die "Sicherheitshinweise in der Produktanleitung" Ihres Monitors. Lesen Sie auch die umfassende Liste mit Funktionen in Ihrer Bedienungsanleitung.

Prima di installare e utilizzare il monitor Dell, leggere le norme di sicurezza sull'uso del monitor "Guida informativa al prodotto". Si veda anche la Guida utente per avere l'elenco completo delle funzioni.

Przed wykonaniem ustawień i rozpoczęciem używania monitora Dell należy przeczytać instrukcje bezpieczeństwa w "Podręczniku informacji o produkcie" monitora. Informacje dotyczące pełnej listy funkcji znajdują się w Podręczniku użytkownika.

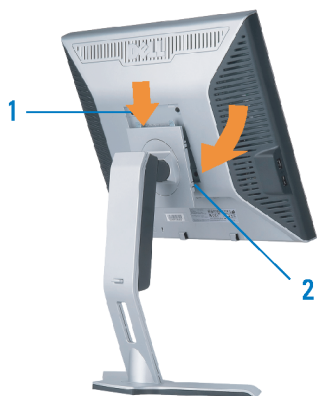

**1**

### Attach the monitor to the stand.

Fixez le moniteur sur le socle.  
Acople el monitor a la base.  
Coloque o monitor no suporte.  
Den Monitor auf den Fuß befestigen.  
Fissare il monitor alla base.  
Podłącz monitor do podstawy.

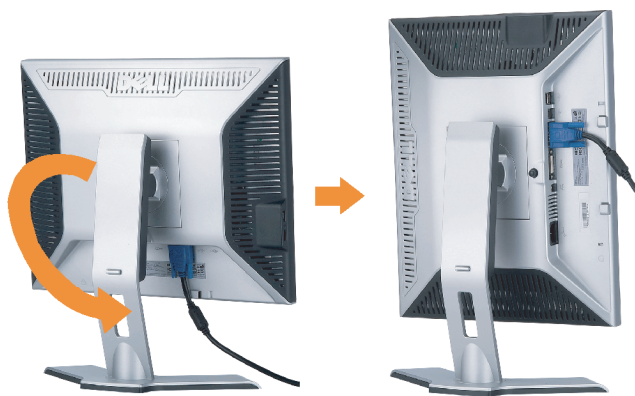

**2**

### Rotate the monitor to connect the cables.

Pivotez le moniteur pour connecter les câbles.  
Gire el monitor para conectar los cables.  
Rode o monitor para ligar os cabos.  
Drehen Sie den Monitor um die eigene Achse, um die Kabel anzuschließen.  
Ruotare il monitor per collegare i cavi.  
Obróć monitor w celu podłączenia kabli.

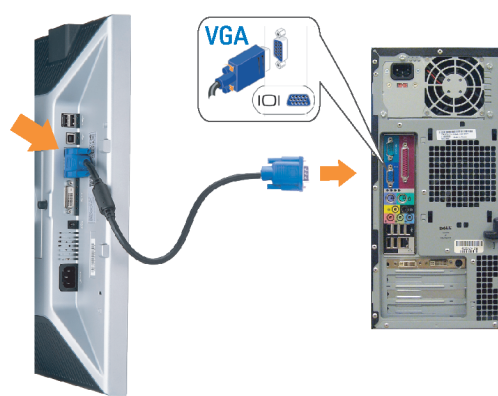

**3**

### Connect the blue VGA cable to the computer.

Connectez le câble VGA bleu à votre ordinateur.  
Conecte el cable VGA azul al equipo.  
Ligue o cabo VGA ao computador.  
Schließen Sie das blaue VGA-Kabel an den Computer an.  
Collegare il cavo VGA di color blu al computer.  
Podłącz niebieski kabel VGA do komputera.

**OR**

ou  
o  
ou  
oder  
e  
lub

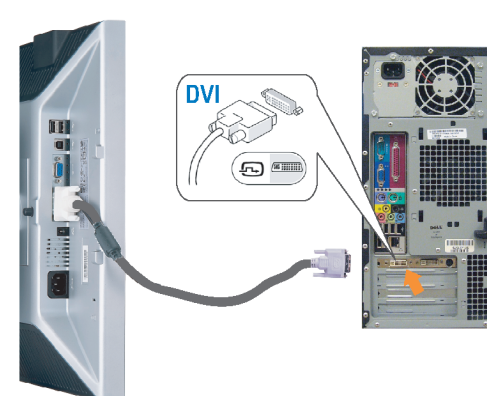

### Connect the optional white DVI cable to the computer.

Connectez le câble DVI blanc optionnel à votre ordinateur.  
Conecte el cable DVI blanco opcional al equipo.  
Ligue o cabo DVI branco opcional ao computador.  
Schließen Sie das optionale, weiße DVI-Kabel an den Computer an.  
Collegare il cavo DVI opzionale, di colore bianco, al computer.  
Podłącz opcjonalny, biały kabel DVI do komputera.

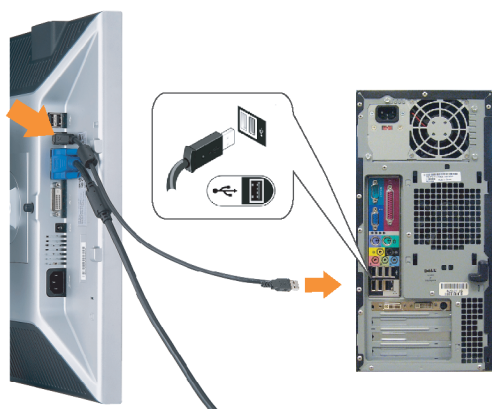

**4**

### Connect the USB cable to the computer.

Connectez le câble USB sur l'ordinateur.  
Conecte el cable USB a su computador.  
Ligue o cabo USB ao computador.  
Verbinden Sie das USB-Kabel mit dem Computer.  
Collegare il cavo USB al computer.  
Podłącz kabel USB do komputera.

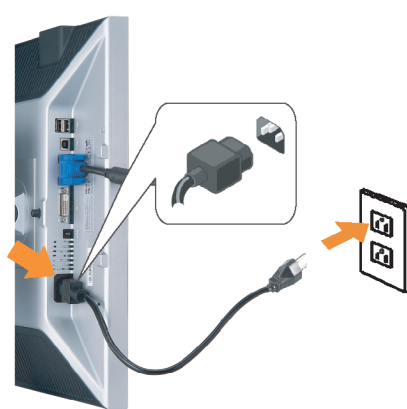

**5**

### Connect the power cord firmly to the monitor and the electrical outlet.

Connectez fermement le cordon d'alimentation au moniteur et à une prise murale.  
Conecte el cable de alimentación firmemente al monitor y a la toma de corriente.  
Ligue o cabo de alimentação ao monitor e à tomada elétrica.  
Schließen Sie die Netzleitung ordnungsgemäß an den Monitor und eine Steckdose an.  
Collegare bene il cavo di alimentazione al monitor e alla presa elettrica.  
Podłącz pewnie przewód zasilający do monitora i gniazdka elektrycznego.



**6**

### Rotate the monitor back and turn on the monitor.

Pivotez de nouveau le moniteur pour retrouver sa position initiale et allumez-le.  
Vuelva a girar el monitor y enciéndalo.  
Rode o monitor para a posição original e ligue-o.  
Drehen Sie den Monitor wieder in die Ausgangsposition und schalten Sie ihn ein.  
Ruotare il monitor per riportarlo nella posizione originale e accenderlo.  
Obróć monitor do poprzedniej pozycji i włącz monitor.

**7**

### If nothing appears on the screen, press the Input Select button.

Si aucune image n'apparaît sur l'écran, appuyez sur le bouton Sélection d'Entrée.  
Si no aparece nada en la pantalla, pulse el botón Selección de entrada.  
Se não aparecer nada no ecrã, prima o botão seleção de entrada.  
Wenn nichts auf dem Bildschirm erscheint, drücken Sie bitte die Eingangsauswahl-Taste.  
Se sullo schermo non appare nulla, premere il tasto Seleziona ingresso.  
Jeśli nic nie wyświetli się na ekran naciśnij przycisk Wybór wejścia.



7730203259P0B

www.dell.com | support.dell.com



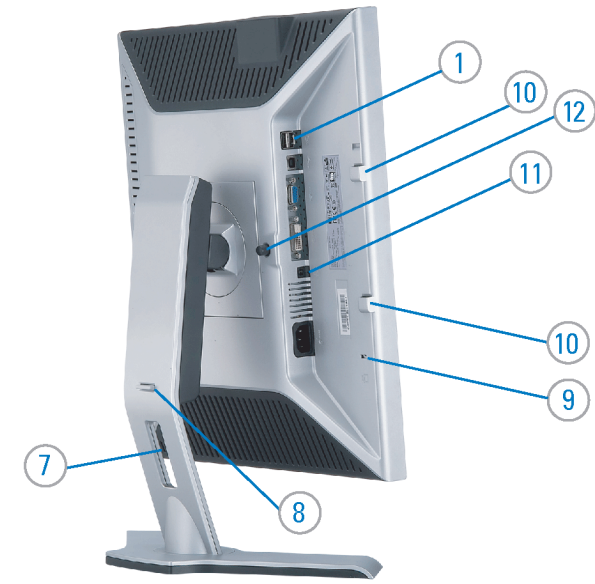
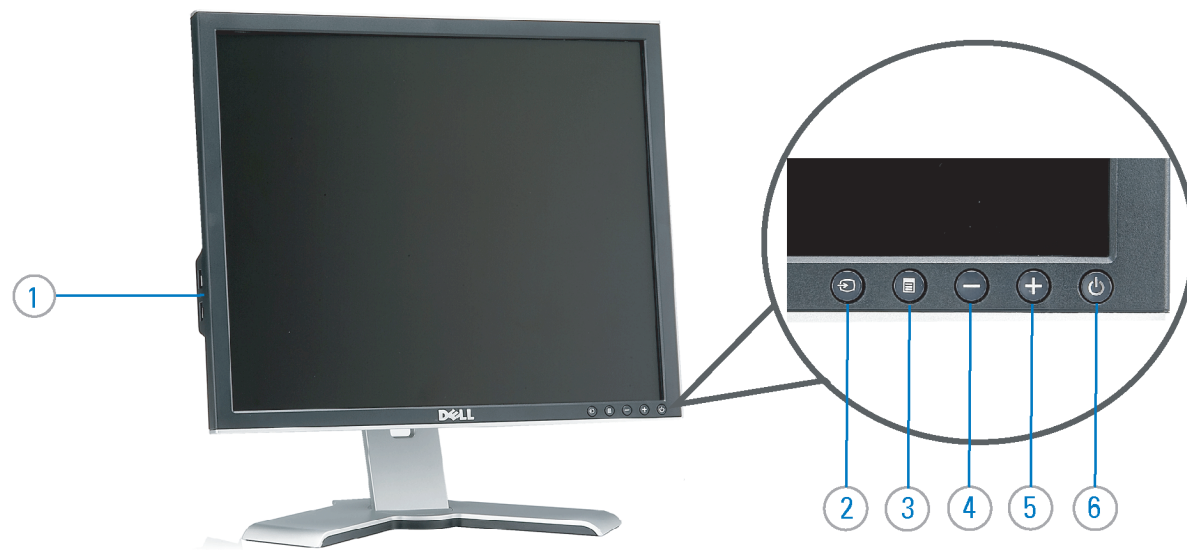

1. USB downstream port
2. Video Input Select
3. OSD Menu/Select
4. Down
5. Up
6. Power button (with power light indicator)
7. Cable management hole
8. Lock down/release button
9. Security lock slot
10. Dell Soundbar mounting brackets
11. Power Out for Dell Soundbar
12. Monitor Lock/Release Button

1. Port USB flux descendant
2. Sélectionner l'Entrée vidéo
3. Menu OSD/Sélectionner
4. Bas
5. Haut
6. Bouton Alimentation (avec témoin lumineux d'alimentation)
7. Trou de rangement des câbles
8. Bouton verrouillage/libération
9. Orifice de verrouillage de sécurité
10. Support de montage de la Soundbar Dell
11. Sortie alimentation pour Dell Soundbar
12. Moniteur verrouillage/déverrouillage du panneau LCD

1. Puerto de descarga USB
2. Seleccionar entrada de vídeo
3. Menú OSD/Seleccionar
4. Bajar
5. Subir
6. Botón de encendido (con indicador luminoso de encendido)
7. Orificio para la administración de cables
8. Botón para bloque/liberación
9. Ranura de bloqueo de seguridad
10. Soportes de montaje para la barra de sonidos Dell
11. Desconexión para Dell Soundbar
12. Botón para bloquear o liberar el panel LCD

1. Porta USB downstream
2. Seleccionar entrada de video
3. Menu OSD/Seleccionar
4. Para baixo
5. Para cima
6. Botão de alimentação (com LED indicador de alimentação)
7. Orifício para gestão dos cabos
8. Botão de fixação/libertação
9. Ranhura para travamento de segurança
10. Suportes de montagem para o Dell Soundbar
11. Desligar sistema de som Dell
12. Botão de bloqueio/desbloqueio do painel LCD

1. USB-Downstream-Anschluss
2. Videoeingang-Auswahl/Unten
3. OSD Menü/Auswahl
4. Unten
5. Oben
6. Netzschalter (mit Betriebsanzeige)
7. Loch für Kabelverwaltung
8. Taste Einrasten/Ausrasten
9. Diebstahlsicherung
10. Dell Soundbar-Montagehalter
11. Ausschalter für Dell Soundbar
12. Bildschirm Ver-/Entriegelungstaste

1. Porta USB per il downstream
2. Selezione ingresso video
3. Menu OSD/Selezione
4. Giù
5. Su
6. Tasto di accensione (con indicatore luminoso)
7. Foro per il passaggio dei cavi
8. Pulsante blocco/rilascio
9. Slot per blocco di sicurezza
10. Staffe di montaggio Dell Soundbar
11. Uscita alimentazione per Soundbar Dell
12. Tasto blocco/rilascio pannello

1. Port pobierania danych (downstream) USB
2. Wybór wejścia video
3. Menu OSD/Wybór
4. W dół
5. W górę
6. Przycisk zasilania (ze wskaźnikiem zasilania)
7. Otwór prowadzenia kabli
8. Przycisk blokowania/zwolnienia blokady
9. Gniazdo blokady zabezpieczenia
10. Wsporniki montażowe Dell Soundbar
11. Panela dźwiękowego Dell
12. Przycisk blokady/zwolnienia monitor

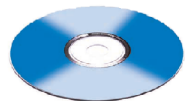

### Finding Information

See your monitor User's Guide in the CD, for more information.

### Trouver les Informations

Référez-vous au Guide Utilisateur de votre moniteur sur le CD pour les informations complémentaires.

### Búsqueda de información

Para obtener más información consulte la Guía del usuario del monitor contenida en el CD.

### Procurar informação

Para obter mais informações, consulte o Guia do usuário do seu monitor que vem incluído no CD.

### Finden von Informationen

Weitere Informationen sind in der Bedienungsanleitung Ihres Monitors auf der CD angegeben.

### Dove reperire informazioni

Consultare la Guida utente nel CD, per avere maggiori informazioni.

### Znajdowanie informacji

Dalsze informacje znajdują się w Podręczniku użytkownika monitora na dysku CD.

Information in this document is subject to change without notice.  
© 2005 Dell Inc. All rights reserved.

Reproduction in any manner whatsoever without the written permission of Dell Inc. is strictly forbidden.

Dell and the DELL logo are trademarks of Dell Inc. Dell disclaims proprietary interest in the marks and names of others.

November 2005

Les informations contenues dans ce document peuvent être soumises à des modifications sans préavis.  
© 2005 Dell Inc. Tous droits réservés.

Toute reproduction, par quelque manière que ce soit, est strictement interdite sans l'autorisation écrite de Dell Inc.

Dell et le logo DELL sont la propriété de Dell Inc. Tous les autres noms commerciaux ou noms de marques sont la propriété de leurs détenteurs respectifs.

Novembre 2005

La información contenida en este documento está sujeta a cambios sin previo aviso.  
© 2005 Dell Inc. Reservados todos los derechos.

Se prohíbe estrictamente la reproducción de este documento en cualquier forma sin permiso por escrito de Dell Inc.

Dell y el logotipo DELL son marcas registradas de Dell Inc. Dell renuncia al derecho de posesión sobre las marcas y nombres de terceros.

Noviembre 2005

As informações contidas neste documento estão sujeitas a alterações sem aviso prévio.  
© 2005 Dell Inc. Corporation. Todos os direitos reservados.

A reprodução de qualquer forma sem permissão por escrito de Dell Inc. é estritamente proibida.

Dell e o logotipo DELL são marcas comerciais da Dell Inc. A Dell exclui quaisquer interesses de propriedade nas marcas e nomes de outros.

Novembro 2005

Die Informationen in diesem Dokument unterliegen unangekündigten Änderungen.  
© 2005 Dell Inc. Alle Rechte vorbehalten.

Die Vervielfältigung dieses Dokuments in jeglicher Form ist ohne schriftliche Genehmigung der Dell Inc. streng untersagt.

Dell und des DELL-Logo sind Warenzeichen der Dell Inc. Dell erhebt keinerlei Eigentumsansprüche auf Warenzeichen und Namen Dritter.

November 2005

Le informazioni contenute in questo documento sono soggette a variazioni senza preavviso.  
© 2005 Dell Inc. Tutti i diritti riservati.

È severamente proibita la riproduzione di qualsiasi elemento senza il permesso scritto di Dell Inc.

Dell e il logo DELL sono marchi registrati di Dell Inc. Dell non riconosce interesse di proprietà esclusiva nei marchi e nelle denominazioni di altri.

Novembre 2005

Informacje zawarte w niniejszym dokumencie mogą ulec zmianie bez uprzedzenia.  
© 2005 Dell Inc. Wszystkie prawa zastrzeżone.

Powielanie niniejszego dokumentu przy użyciu jakiegokolwiek techniki bez pisemnej zgody Dell Inc. jest surowo zabronione.

Dell logo DELL to znaki towarowe firmy Dell Inc. Firma Dell nie zgłasza żadnych praw do marek i nazw innych firm.

Listopad 2005







# Setting Up Your Monitor

設定您的監視器 | 安裝顯示器 | モニターのセットアップ | 모니터 설치 | การตั้งค่าหน้าจอ



**CAUTION:**

Before you set up and operate your Dell monitor, see the safety instructions in your monitor "Product Information Guide" See your User's Guide for a complete list of features.

**注意：**

設定和操作您的 Dell 顯示器前，請先參閱隨附《產品資訊指南》中的安全說明。有關顯示器功能的完整介紹也請參閱《使用指南》。

**警告：**

在設置和使用 Dell 顯示器之前，請參閱顯示器《產品信息指南》中的安全注意事項。此外，還請參閱用戶指南以了解全部特性。

**注意：**

Dell モニタをセットアップして操作する前に、モニタの“製品情報ガイド”の安全に関する注意事項をご覧ください。また、機能の完全なリストについてはユーザーズガイドをご覧ください。

**주의：**

Dell 모니터를 설치하고 작동하기 전에 모니터 “제품 정보 가이드”의 안전 지침을 참조하십시오. 또한, 기능의 전체 목록은 사용자 가이드를 참조하십시오.

**ข้อควรระวัง:**

ก่อนที่จะติดตั้งและใช้งานจอภาพเคลือบของคุณ ให้อ่านขั้นตอนเพื่อความปลอดภัยใน “คู่มือข้อมูลผลิตภัณฑ์” ของจอภาพก่อน นอกจากนี้ ให้อ่าน คู่มือผู้ใช้ ของคุณ เพื่อดูรายการคุณสมบัติที่สมบูรณ์

## Dell™ 1707FP Flat Panel Monitor

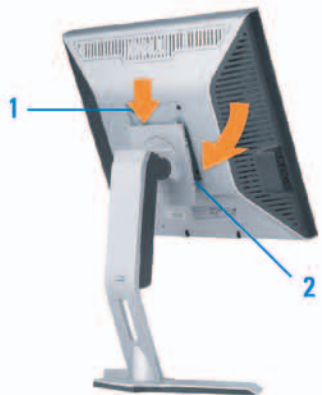

### 1 Attach the monitor to the stand.

將監視器裝在腳座上。  
將顯示器與底座相連。  
モニタをスタンドに取り付けます。  
모니터를 스탠드에 부착합니다.  
ต่อจอภาพเข้ากับขาตั้ง

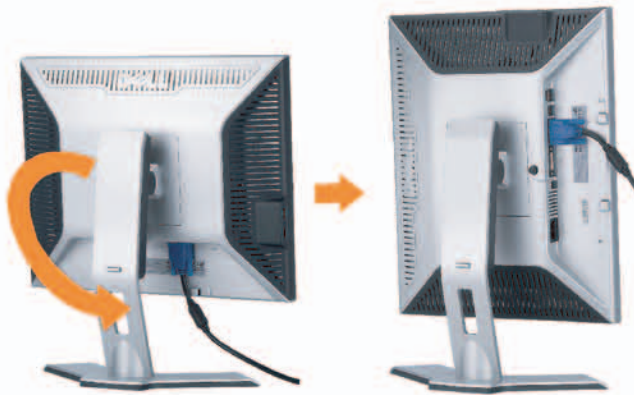

### 2 Rotate the monitor to connect the cables.

旋轉顯示器以便連接各連接線。  
旋轉顯示器以連接線纜。  
モニタを回転してケーブルを接続します。  
모니터를 회전시켜 케이블을 연결합니다.  
หมุนจอภาพเพื่อเชื่อมต่อสายต่างๆ

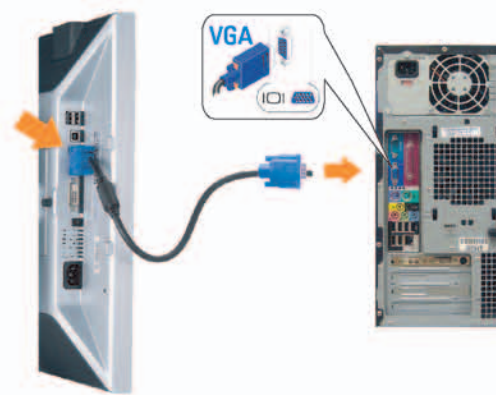

### 3 Connect the blue VGA cable to the computer.

將藍色 VGA 連接線連接至電腦。  
將藍色 VGA 線連接到計算機。  
青いVGAケーブルをコンピュータに接続します。  
청색 VGA 케이블을 컴퓨터에 연결합니다.  
เชื่อมต่อสายเคเบิล VGA สีฟ้าไปยังคอมพิวเตอร์

**OR**

或  
或  
または  
또는  
หรือ

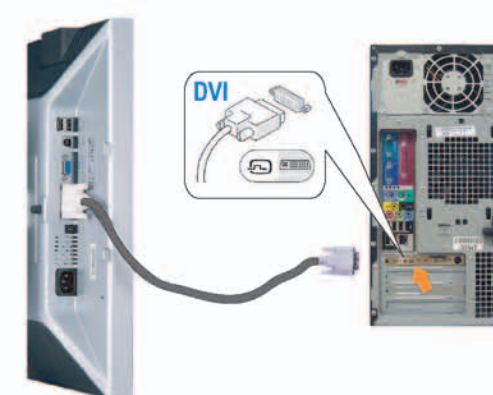

### Connect the optional white DVI cable to the computer.

將選購的白色 DVI 連接線連接至電腦。  
將選購的白色 DVI 線連接到計算機。  
オプションの白いDVIケーブルをコンピュータに接続します。  
백색 DVI 케이블(옵션)을 컴퓨터에 연결합니다.  
เชื่อมต่อสายเคเบิล DVI สีขาวซึ่งเป็นอุปกรณ์เชื่อมต่อเพิ่มไปยังคอมพิวเตอร์

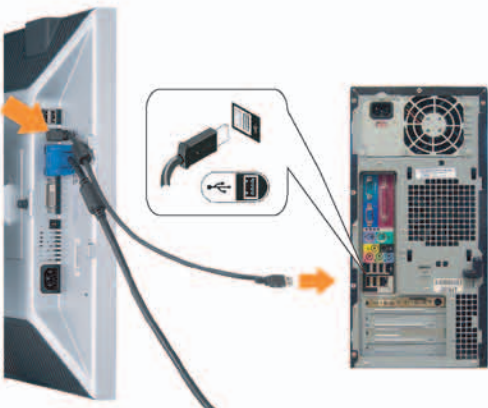

### 4 Connect the USB cable to the computer.

將USB纜線連接到電腦上。  
將 USB 線連接到計算機。  
USBケーブルコンピュータに接続します。  
USB 케이블을 컴퓨터에 연결합니다.  
เชื่อมต่อสายเคเบิล USB ไปยังคอมพิวเตอร์

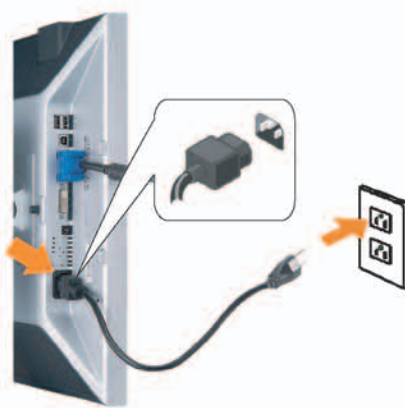

### 5 Connect the power cord firmly to the monitor and the electrical outlet.

將電源線確實地連接至顯示器和電源插座。  
將電源線牢固插入顯示器和電源插座。  
電源コードをモニタとコンセントにしっかり接続します。  
전원 코드를 모니터와 전기 콘센트에 단단하게 연결합니다.  
เชื่อมต่อสายไฟไปยังคอมพิวเตอร์และเต้าเสียบไฟฟ้าอย่างแน่นหนา



### 6 Rotate the monitor back and turn on the monitor.

將顯示器轉回原位並開啟顯示器電源。  
將顯示器旋轉回原位，然後打開顯示器電源。  
モニタを回転して元に戻し、モニタの電源をオンにします。  
모니터를 다시 회전시킨 후 모니터를 켭니다.  
หมุนจอภาพกลับ และเปิดจอภาพ



### 7 If nothing appears on the screen, press the Input Select button.

若螢幕沒顯示畫面，請按“輸入選擇”按鈕。  
如果屏幕上無顯示，請按“輸入選擇”按鈕。  
画面に何も表示されない場合、「入力選択」ボタンを押してください。  
화면에 아무것도 나타나지 않으면 [입력 선택] 버튼을 누릅니다.  
ถ้าไม่มีอะไรปรากฏขึ้นบนหน้าจอ ให้กดปุ่ม Input Select (เลือกสัญญาณเข้า)



7730203295P0A

www.dell.com | support.dell.com





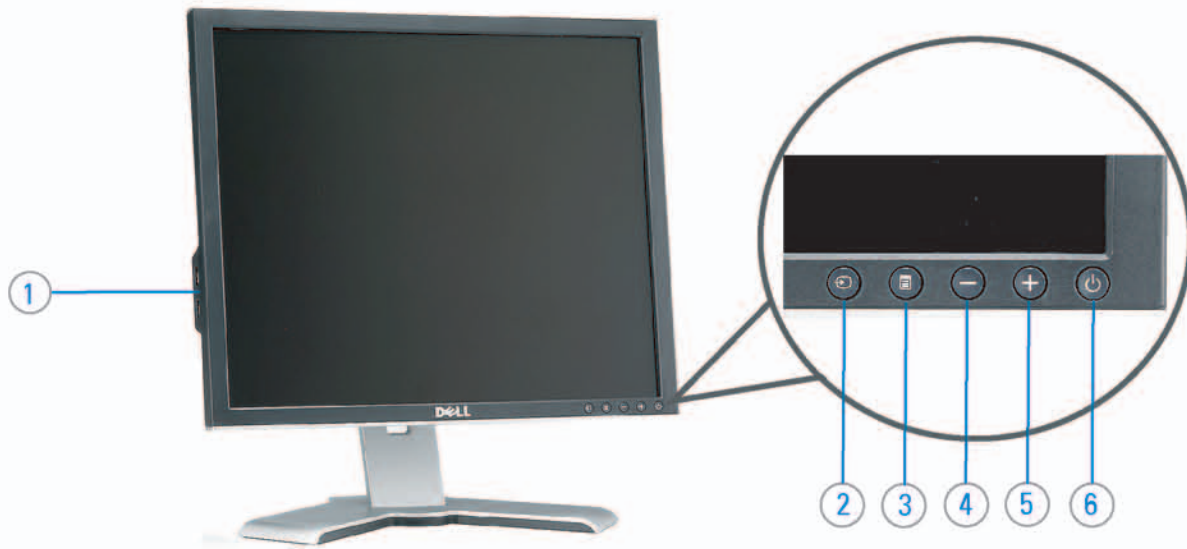

1. USB downstream port
2. Video Input Select
3. OSD Menu/Select
4. DOWN
5. Up
6. Power button (with power light indicator)
7. Cable management hole
8. Lock down/release button
9. Security lock slot
10. Dell Soundbar mounting brackets
11. Power Out for Dell Soundbar
12. Monitor Lock/Release Button

1. USB 下游連接埠
2. 影像輸入選擇
3. OSD 功能表/選擇
4. 下
5. 上
6. 電源按鈕 (帶有電源指示燈)
7. 纜線理線孔
8. 鎖定/釋放按鈕
9. 安全鎖插槽
10. Dell Soundbar 勾槽托架
11. Dell Soundbar 電源輸出
12. 銀幕鎖定/鬆開按鈕

1. USB 下行端口
2. 視頻輸入選擇
3. OSD 菜單/選擇
4. 向下
5. 向上
6. 電源按鈕 (帶電源指示燈)
7. 纜線管理孔
8. 鎖按下/鬆開按鈕
9. 防盜鎖插槽
10. Dell Soundbar 安裝架
11. Dell Soundbar 電源輸出
12. 銀幕鎖定/釋放按鈕

1. USBダウンストリームポート
2. ビデオ入力選択
3. OSDメニュー/選択
4. 下
5. 上
6. 電源ボタン (電源ライトインジケータ付き)
7. ケーブル管理ホール
8. ロックダウン/リリースボタン
9. セキュリティロックスロット
10. Dell サウンドバー取付ブラケット
11. Dell Soundbar 用の電源コネクタ
12. パネルロック/リリースボタン

1. USB 다운스트림 포트
2. 비디오 입력 선택
3. OSD메뉴/선택
4. 아래로
5. 위로
6. 전원 버튼 (전원 표시등)
7. 케이블 관리 구멍
8. 잠금/해제 버튼
9. 도난 방지 장치 슬롯
10. Dell Soundbar 설치 브래킷
11. Dell Soundbar 전원 출력
12. 패널 잠금/잠금 해제 버튼

1. พอร์ตดาวน์โหลด USB
2. เลือกสัญญาณภาพเข้า
3. เมนู OSD /เลือก
4. ลง
5. ขึ้น
6. ปุ่มเพาเวอร์ (พร้อมไฟแสดงสถานะเพาเวอร์)
7. รูสำหรับจัดระเบียบสายเคเบิล
8. ปุ่มล็อค/คลาย
9. ล็อคเคนซิงค์
10. ที่ติดแถบเสียง Dell
11. ไฟไฟเข้าแถบเสียง Dell
12. ปุ่มล็อค/ปลดล็อคแผ่นจอ



### Finding Information

See your monitor *User's Guide* in the CD, for more information.

### 尋找資訊

詳細資訊請參閱光碟中的顯示器《使用指南》。

### 查找信息

有关的详细信息, 请参阅光盘中的显示器用户指南。

### 検索情報

詳細については、CDのモニターユーザーガイドをご覧ください。

### 정보 찾기

더 자세한 정보는 CD에 포함된 모니터 사용자 가이드를 참조하십시오.

### การค้นหาคำข้อมูล

สำหรับข้อมูลเพิ่มเติมให้อ่าน คู่มือผู้ใช้ในแผ่นซีดี

Information in this document is subject to change without notice.  
© 2005 Dell Inc. All rights reserved.

Reproduction in any manner whatsoever without the written permission of Dell Inc. is strictly forbidden.  
Dell and the DELL logo are trademarks of Dell Inc. Dell disclaims proprietary interest in the marks and names of others.

November 2005

本指南的內容如有變更, 恕不另行通知。  
© 2005 Dell Inc. 版權所有。

未經 Dell Inc. 的書面許可, 嚴禁任何形式的非法複製。  
Dell 及 DELL 標誌為 Dell Inc. 的商標。其他標誌和名稱的所有權皆不屬 Dell 所有。

2005年11月

本指南的內容如有變更, 恕不另行通知。  
© 2005 Dell Inc. 版權所有。

未經 Dell Inc. 的書面許可, 嚴禁任何形式的非法複製。  
Dell 和 DELL 標誌是 Dell Inc. 的商標。Dell 對非 Dell 公司的商標和商標名稱的所有權。

2005年11月

本書に記載されている事項は事前通告無しに変更されることがあります。  
© 2005 すべての著作権は Dell Inc. にあります。

Dell Inc. からの書面による許可なく本書の複写、転載を禁じます。  
Dell と DELL のロゴマークは、Dell Inc. の登録商標です。上記記載以外の商標や会社名が使用されている場合がありますが、これらの商標や会社名は、一切 Dell Inc. に所属するものではありません。

2005年11月

이 안내서에 있는 내용은 사전 통보 없이 변경될 수 있습니다.  
© 2005 Dell Inc. 모든 권리 소유.

Dell Inc. 의 서면 승인 없이 재작성 또는 복제 행위는 일격히 금지합니다.  
Dell 과 Dell 로고는 Dell Inc. 의 등록상표입니다. Dell 은 자사 이외의 상표 및 상품명에 대해서는 어떤 소유권도 인정하지 않습니다.

2005년11월

เนื้อหาของผู้จัดทำข้อมนี้ อาจเปลี่ยนแปลงได้โดยไม่แจ้งก่อนล่วงหน้า  
© 2005 Dell Inc. สงวนลิขสิทธิ์

ห้ามคัดลอก โดยไม่ได้รับอนุญาตจากบริษัท เดลล์ เดลล์ หรือ Dell Inc.  
Dell และโลโก้ Dell เป็นเครื่องหมายการค้าของบริษัท เดลล์ เดลล์ หรือ Dell Inc. บริษัท เดลล์ เดลล์ หรือ Dell Inc. ไม่รับผิดชอบต่อการใช้ชื่อของผู้อื่นหรือเครื่องหมายการค้าที่เลียนแบบ

พฤศจิกายน 2005

